

■Features

- High Luminous Super Flux Output
- Superior Weather-resistance
- UV Resistant Epoxy
- Water Clear Type

■Applications

- Automotive Dashboard Lighting
- Traffic Signal Lamp
- Back Lighting
- Other Lighting

■Outline Dimension

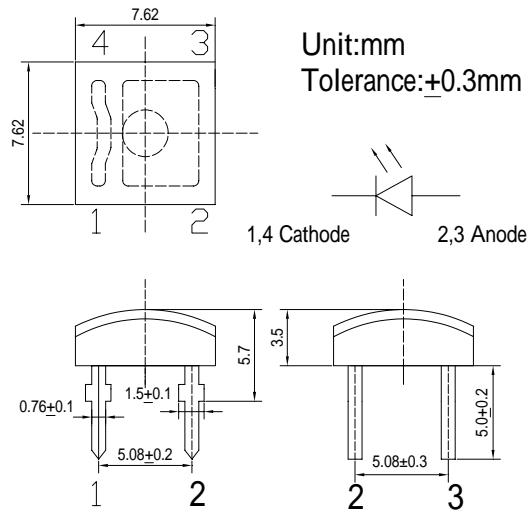

■Absolute Maximum Rating

(Ta=25)

Item	Symbol	Value	Unit
DC Forward Current	I _F	90	mA
Pulse Forward Current*	I _{FP}	200	mA
Reverse Voltage	V _R	5	V
Power Dissipation	P _D	234	mW
Operating Temperature	Topr	-30 ~ +85	
Storage Temperature	Tstg	-40~ +100	
Lead Soldering Temperature	Tsol	260 /5sec	-

*Pulse width Max.10ms Duty ratio max 1/10

■Directivity

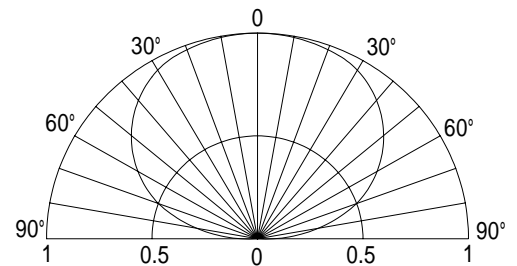

■Electrical -Optical Characteristics

(Ta=25)

Item	Symbol	Condition	Min.	Typ.	Max.	Unit
DC Forward Voltage	V _F	I _F =90mA	1.9	2.2	2.6	V
DC Reverse Current	I _R	V _R =5V	-	-	30	μA
Domi. Wavelength	λ _D	I _F =90mA	620	625	630	nm
Luminous Intensity	I _v	I _F =90mA	5800	8000	-	mcd
50% Power Angle	2θ _{1/2}	I _F =90mA	-	140	-	deg

*1 Tolerance of dominant wavelength is ±1nm

*2 Tolerance of luminous intensity is ±15%